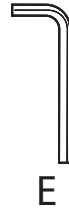
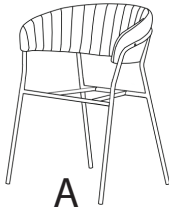
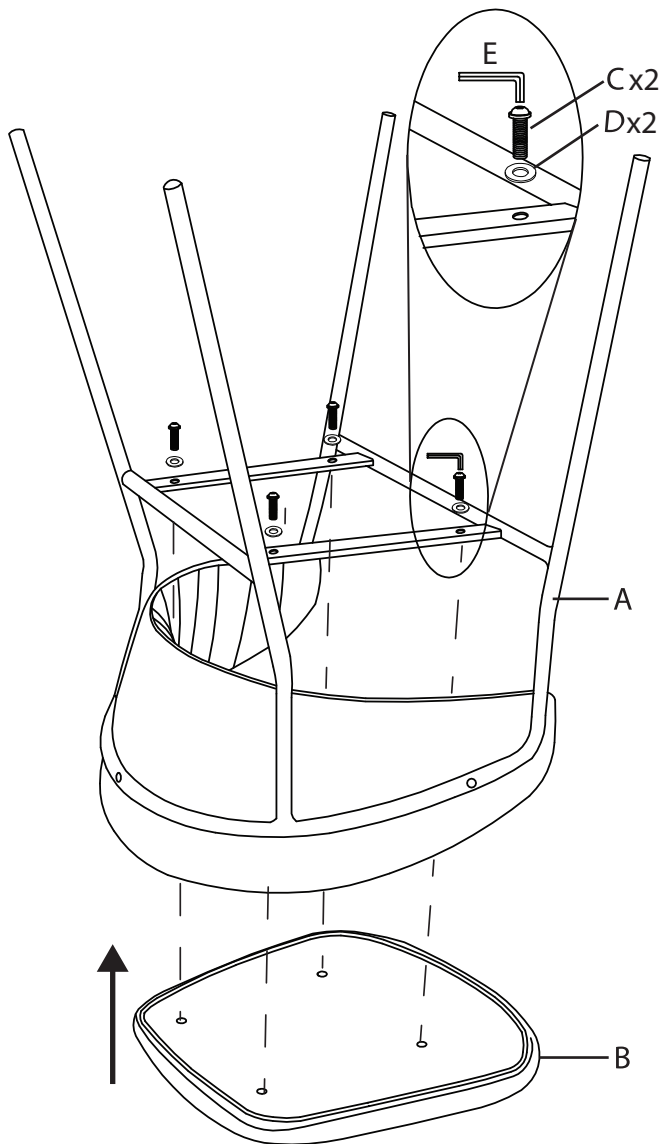
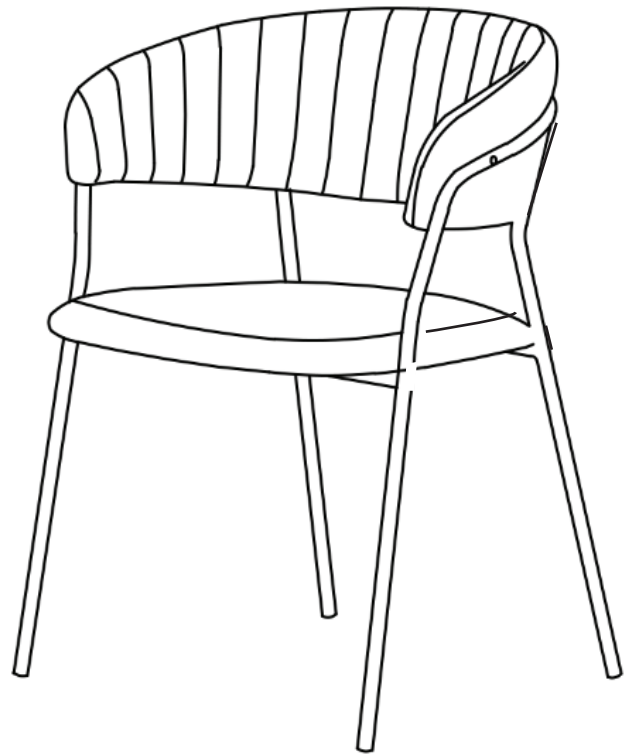

Part # CH-TANIA XX+XX

18-1129

PARTS**1****2**

Do not over tighten.
Do not use power tools to assemble.